

NUCOR

BUILDING SYSTEMS

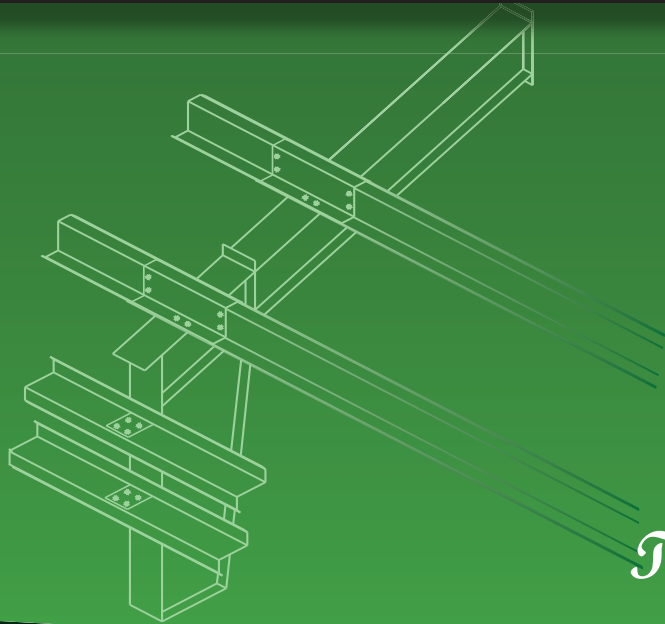

The Brand of Choice

METAL BUILDING SYSTEMS

www.nucorbuildingsystems.com



NUCOR Building Systems

The Brand of Choice

Nucor Building Systems, a division of Nucor Corporation, is one of the most flexible and diverse building manufacturers in operation today. Nucor Corporation is a Fortune 500 Company, producing steel and steel products. Nucor has been heavily involved in industrial and commercial projects for many years. Nucor has earned a reputation for providing the highest quality products and an outstanding record for customer satisfaction. Complete metal building packages can be customized and combined with other materials such as storefront glass and masonry to produce a cost effective, aesthetically sound building designed for your special requirements.



As a custom manufacturer, Nucor produces a wide array of structural systems including: clearspan rigid frame, modular rigid frame, tapered beam, and lean-to. All are available in standard or long span options. Crane support systems and mezzanines can also be included as part of the complete building package. Your Nucor building can be designed to virtually any desired dimension to achieve the optimal solution for your building requirements.



Nucor Building Systems is IAS AC 472 accredited. IAS (International Accreditation Service) in cooperation with the MBMA, is the new, high quality standard certification program written specifically for the metal building industry. AC 472 consists of three parts: structural, cold formed, and design, and encompasses all manufacturing practices and engineering common to the pre-engineered metal building manufacturing industry.



Professional Engineering Services

Nucor Building Systems is a building systems manufacturer incorporating the latest engineering knowledge in the industry today. A full staff of in-house engineers and detailing personnel ensure prompt and efficient consideration of all design needs.

All engineering follows industry specifications and standards published by the American Iron and Steel Institute, Factory Mutual, and the Metal Building Manufacturers Association. All buildings are designed and certified by company registered professional engineers in accordance with the loading information specified to Nucor on the signed Nucor

Order Documents and in compliance with the MBMA. Engineering services and products can also be provided for second-story floors, mezzanines, crane bays, and other building accessories.



Your Custom Designed Building



Nucor Building Systems will custom design your facility. Your design criteria will be specified by your local project engineer of record and communicated on the Nucor Order Documents.

The project engineer of record must be knowledgeable regarding the geographical area of the building site as well as the building's functional requirements.

All designs are in accordance with the MBMA Metal Building Systems Manual and adhere to your specified building code.

Primary Framing

Clearspan - Rigid Frame (RCG)

This tapered member frame can be used in clearspan situations from 40 to 250 feet. It can be either gable or single slope. Common roof slopes of 1/4 to 6 in 12 are offered. When large clearspan areas are required for special industrial and commercial projects, the Clearspan Frame type is typically the economical choice.

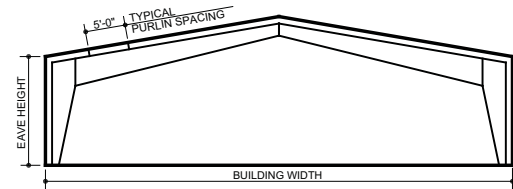

Single Slope (RCS)

A single slope rigid frame is commonly used on retail centers or as a creative way of adding to an existing structure. Can be used with either cold-form purlins or open web joists.

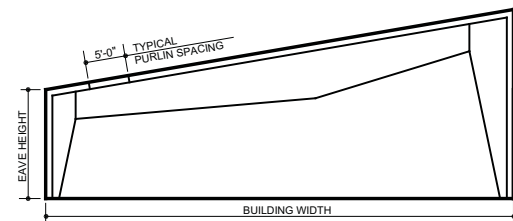

Modular - Rigid Frame (RMG) and Single Slope (RMS)

The solid web rigid frame with interior columns provides multiple spans on wider buildings. It can be either gable or single slope. This frame type is economical with individual spans of 30 to 80 feet and building widths from 60 feet to 300 feet or more. Roof slopes are 1/4 to 4 in 12. Modular frames can be used with either cold-form purlins or open web joists.

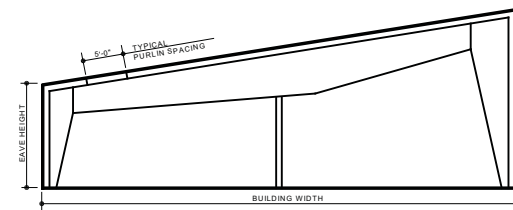
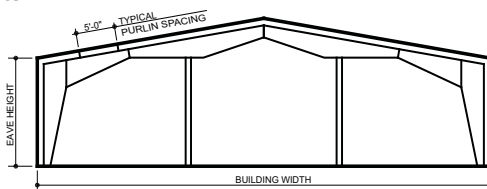

Lean-To (LCS)

The Lean-To frame joins to and is supported by a main building frame. Common spans are 20 to 60 feet. The lean-to differs from the single slope in that it must be supported on the high side by an adjoining building column.

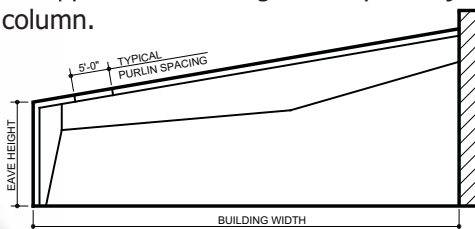

Tapered Beam (TCG)

Designed for maximum efficiency of interior space. Suitable for all types of small buildings that require clearspans from under 60'. Roof slopes of 1/4 to 1 in 12 available. Ideal for partitioning interior bays and small crane support systems.

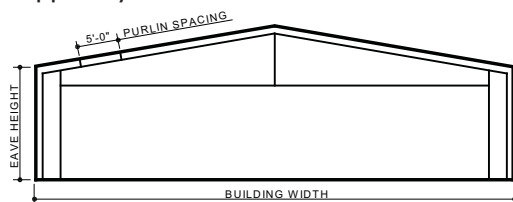

Nucor ClearBay™ Roof Joist System

Nucor's ClearBay system provides open web joists designed to function as an integral part of the pre-engineered building.

ClearBay buildings with open web joists, offer fully bolted connections, with the option of welding. Fully bolted connections lead to faster and easier construction.

Our unique integration of joists with our roof systems result in less bridging, less material, and lower in-place cost.



Long Span Open Web Joists

Long Span System

Joists are very suitable for the support of floors, roof decks, and standing seam roofs. Joists are generally more economical when bay sizes are wider than 30 feet or when roof loads are excessive. "K" series joists are normally used up to 60 feet, while the "LH" and "DLH" series joists are normally used from 60 to 120 feet.

The Nucor "CFR"™ or a conventional roof option is recommended for use with joist roof systems. Open web steel joists are designed and fabricated according to Steel Joist Institute specifications.

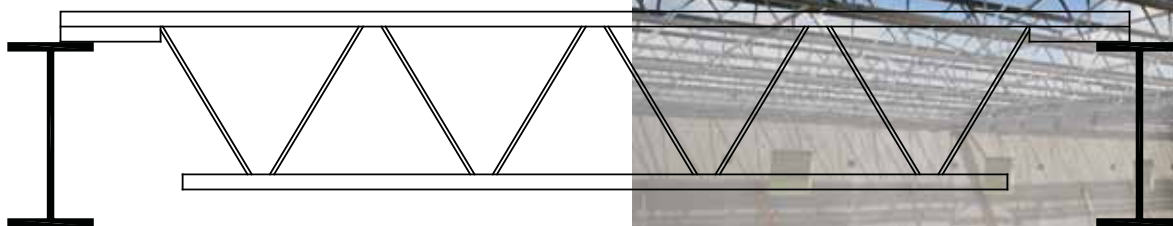
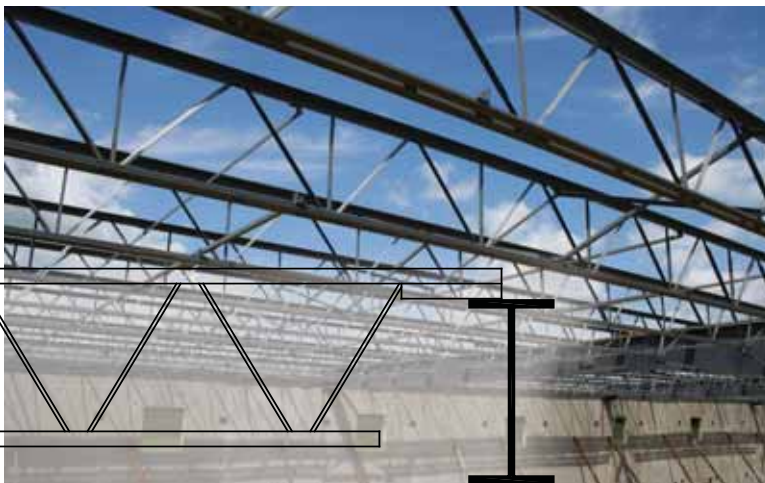

Hardwall Long Span System

Hardwall systems may be applied to a Nucor Long Span building when designed by the Project Engineer of Record. The perimeter is masonry or concrete and can be designed as load bearing or non-load bearing shearwalls.

When designed as load bearing, the need for wall columns is eliminated, therefore offering more interior free space. Roof diaphragm action, roof plane bracing, eave trusses, along with shearwalls are needed to provide lateral stability for the structure.

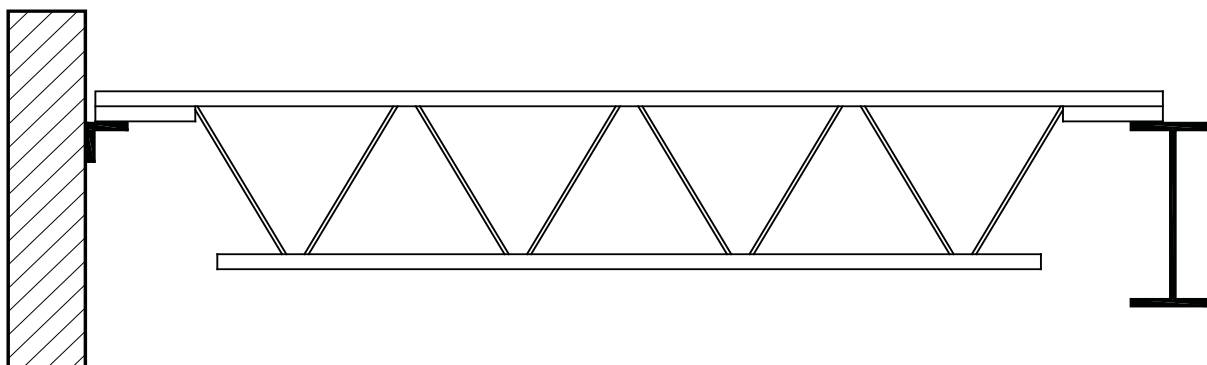

Secondary Framing

Roof Structurals

Nucor Building Systems supplies either cold-formed Zee section purlins or open web bar joists. The decision on which structural members to use will be based on the economy of each member, the roof system used, the product application, or by customer choice at the time of order entry.

Nucor's continuous purlin system meets the stringent requirements of the latest edition of the AISI specification.

Purlins of 12" depth are also available for some applications. Consult Nucor Building Systems for specifics.



Wall Structurals Nucor Building Systems provides 8", 10", & 12" sidewall girts depending on wind loading and column spacing. Sidewall girts can be designed for either inset or bypass applications. Bypass girts offer the most economical sidewall design and are practical when walls are partially open for masonry.

Inset girts are a standard option on endwall conditions and allow for a more efficient use of interior space. The 1" offset prevents a sheeting bulge caused by the compression of insulation at the columns. Girts of 12" depth are also available for some applications. Consult Nucor for specifications.

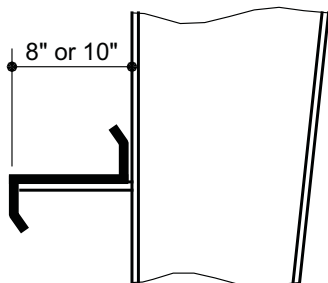

Bypass Girt
(Sidewall Standard)

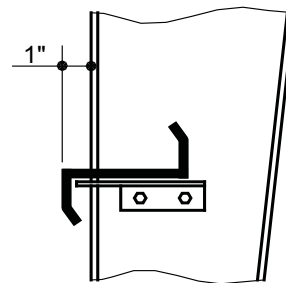

Inset Girt
(Endwall Standard)

Typical Structure Details

Bracing

Nucor Building Systems offers a variety of bracing systems depending upon the type of structure to be designed. A standard rigid frame building will typically use rod or cable bracing in the roof and walls.

Fascia

Fascias enhance the front or entrance areas of buildings. A wide range of fascias are designed by Nucor and can be found in the Nucor Product & Engineering Manual. Nucor fascias may be ordered with open or closed soffits - closed with soffit is our standard condition. Fascia sheeting materials may be steel panel or other material not by Nucor.



Mezzanines

Mezzanines are also included in NBS design options. Nucor Building Systems can provide your floor system either free-standing or in conjunction with your metal building frame.

Items offered by Nucor for mezzanines include columns, beams, floor joists, bridging, floor decking, and deck forming angle.

Miscellaneous steel for stairs, hand-rails, or slab design is not offered by Nucor. Please refer to the Nucor Product & Engineering Manual for more information.

Eave / Rake Extensions and Canopies Canopies and overhangs are available to enhance the exterior appearance of your building. Canopies and eave/rake extensions offer a great aesthetic as well as functional option. The following designs are most commonly used:

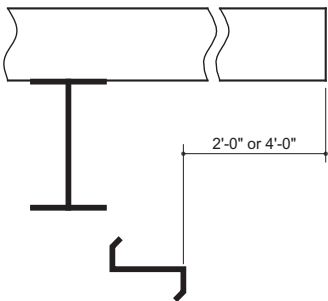

Rake Extension

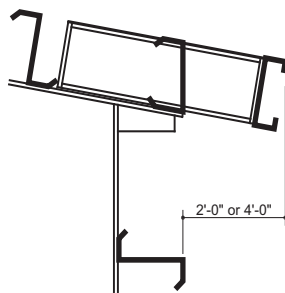

Eave Extension

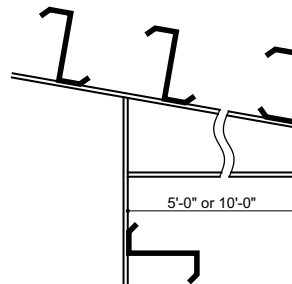

Sidewall Eave Canopy

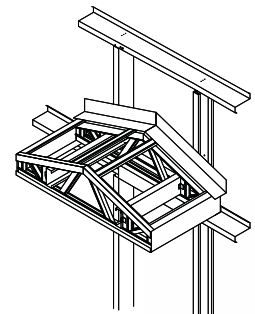

Walkdoor Canopy

Nucor Roof Systems

Nucor Building Systems offers one of the most versatile array of roof choices available.

Choices range from our standard Nucor "Classic Roof" to our state-of-the-art standing seam roof systems, which include the Nucor "CFR", Nucor "Composite CFR", and the Nucor "VR-16 II" vertical rib system.



Nucor "CFR"™ Standing Seam Roof System

Maximum weather protection for low profile roof applications. Nucor "CFR" and Nucor "Composite CFR" standing seam roof systems are available in Galvalume® and standard Nucor colors. Other colors are available upon request. Panel lengths of up to 54'-0" are available. UL90® or Factory Mutual® ratings available upon request. This 24 gauge panel offers 24" coverage with purlin spacing up to 5'-0" and joist spacing 5'-6". See the UL Building Materials Directory & Factory Mutual Approval Guide for more information.



Nucor "VR16 II"™ Vertical Rib Roof System

Mechanically seamed for a weathertight installation, the Nucor "VR16" standing seam offers an attractive and versatile architectural roof system. The back-to-back vertical rib offers easier installation at hips and valleys than trapezoidal or corrugated roof panels. This is a 24 gauge panel with 16" of coverage (22 gauge is available upon request). UL90 and FM ratings are available.



Nucor "Classic Roof"™

Nucor "Classic Roof" is available in a 26 gauge panel with 36" coverage. It is available in Galvalume and Nucor standard colors. Other colors and 24 gauge are available upon special request. Nucor "Classic Roof" panels are a "tried and true" roof system for most purlin applications. Purlin spacing to 5'-0" and joist spacing 5'-6", deck as specified. UL90 Construction 176.



A Few Words About Panel Finish...

Galvalume is one of the most trusted products on the market today, requires very little maintenance, and comes with a 25 year material warranty. Painted roof and wall panels provided by NBS for exterior use are precision roll-formed from pre-printed galvanized or Galvalume coils.

Finished material is subjected to stringent quality control tests including: physical bend and impact resistance, film thickness, hardness, gloss and color. This process is time-tested and uses the industry proven Silicone Polyester paint system. Silicone Polyester paint is a recognized standard of product quality for exterior building wall systems. NBS also offers standard colors which use the Kynar paint system. Warranties available upon request.

Nucor Wall Systems

The wall systems offered by Nucor allow the owner many options for function as well as appearance.

The panels shown are 26 gauge with 36" of coverage, and are available in a range of standard colors. Special colors and gauges are available upon request.

Nucor buildings also interface well with masonry, precast concrete, and tilt-up concrete.



Nucor "Accent Wall"™ (AW)

The architectural features of the Nucor "Accent Wall" make it ideal for fascias and decorative wall designs. The recessed fasteners provide a clean exterior appearance, and the deep rib configuration creates an attractive shadow pattern. Fasteners for the Nucor "Accent Wall" panel are semi-concealed.

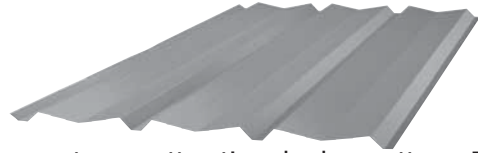

Nucor "Classic Wall"™ (CW)

The Nucor "Classic Wall" provides a strong, attractive wall panel. This panel is ideal for commercial, community, agricultural, and industrial applications. The Nucor "Classic Wall" offers what most builders, contractors, and owners have come to expect in a versatile and attractive building system.



Nucor "Reverse Classic"™ (RC)

The Nucor "Reverse Classic" panel offers a rigid surface designed to compress up to 4" of insulation without causing unsightly bulges at the girt. Fasteners are semi-concealed, allowing attention to focus on the beauty of the wall.



Nucor Liner Panel

Many times liner panels are specified to protect and to finish the building interior. The 28 gauge Nucor Liner Panel is coated with a white polyester paint system and is ideal for most liner conditions not exposed to weather. Where exposure to the effects of weather is a requirement or other colors are requested, specify 26 Gauge Nucor "Classic Wall".



Insulated Wall Panels

Insulated wall panels offer a clean, consistent and high-quality appearance that will add value to any building.

The remarkable light weight of insulated panels also reduces structural requirements and installation costs.

Nucor's insulated wall panels incorporate a finished interior liner, factory applied air and vapor shield, insulated foam core, and a finished exterior weathering surface into a single building unit.

Affordable, Attractive, and Easy to Install

Lightweight and simplified fastening systems deliver quick installation and reduce labor costs. Panels can be installed in adverse weather conditions. A removable film prevents damage to the exterior during shipping and installation.

When it comes to your building, quality and affordability are essential... but so is attractiveness. Now, with Nucor's

insulated wall panels, you can easily meet your needs for a durable, easily constructed, energy efficient, attractive building system.



The Ultimate in Energy Efficiency

No cavities, no gaps, no crushed insulation, and no cold bridges equals 100% reliable thermal performance and insulation continuity. No changes of R-value occurs when purlin and girt center dimensions are varied. The insulation core is one of the most thermally effective insulants available today. Insulation values can be easily increased by simply increasing thickness of the panels, and offer a significant improvement in air-tightness.



NUCOR

BUILDING SYSTEMS

Indiana Plant

305 Industrial Parkway
Waterloo, IN 46793
Ph: 260.837.7891
Fax: 260.837.7384

Northeast Sales Office

201 Granite Drive
Suite 280
Lancaster, PA 17601
Ph: 717.735.7766
Fax: 717.735.7769

South Carolina Plant

P.O. Box 1006
200 Whetstone Rd.
Swansea, SC 29160
Ph: 803.568.2100
Fax: 803.568.2121

Texas Plant

600 Apache Trail
Terrell, TX 75160
Ph: 972.524.5407
Fax: 972.524.5417

Utah Plant

P.O. Box 907
1050 North Watery Lane
Brigham City, UT 84302
Ph: 435.919.3100
Fax: 435.919.3101

www.nucorbuildingsystems.com